

## KNOCK-OUT

2x $\phi 25/\phi 32+\phi 16$

upptill och nertill  
och  $\phi 25$  i botten

Förskruvning

4xM32  $\phi(15-21)$

1xM16  $\phi(5-10)$

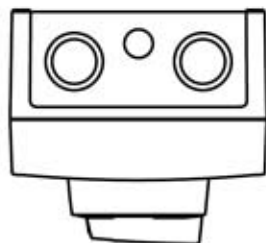
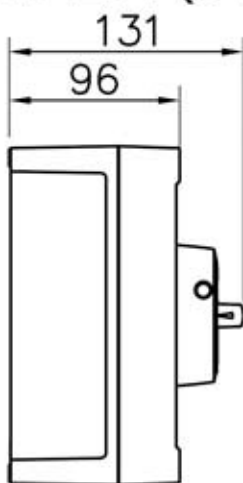
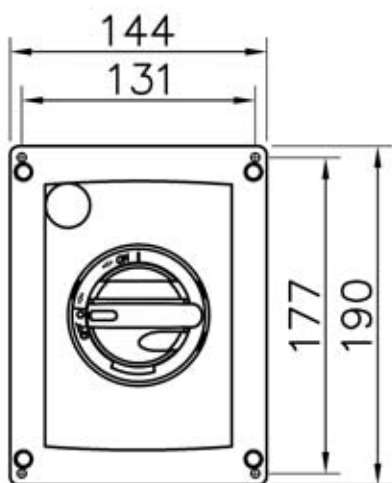
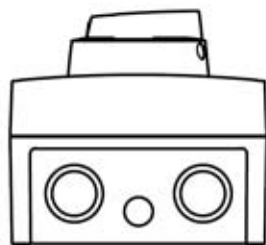

Hjälpkontakt, 1 växlande  
Anslutningar, Cu 2.5-35mm<sup>2</sup>  
N, Cu 2.5-35mm<sup>2</sup>  
PE, Cu 2.5-35mm<sup>2</sup>