

GARO LS4 / LS4 Compact

Installation Manual (EN)

Manual 380144 2.3



GARO AB

Box 203, SE-335 25 Gnosjö
Phone: +46 (0) 370 33 28 00
info@garo.se
garo.se



TABLE OF CONTENT











Safety Information	3
General Information	3

INSTALLATION 4





NORMAL USE 5

Dimensional sketch	9
Technical specifications	10
Service information	10
Form for annual service and maintenance	11
Warranty Conditions	12
Warranty Form / Garantiformulär	13

SAFETY INFORMATION

-  The LS4 stations are designed exclusively for charging electric vehicles.
-  All installation must be carried out by an authorized installer and comply with local country installation regulations. If any questions, please contact your local electrical authority.
-  Refer to local standards and regulations not to exceed charging current limitations.
-  To even out the load, it is important to rotate the phases when connecting several of LS4 stations to the same system. Note that 1-phase charging is common in electric vehicles and L1 (left side) and L2 (right side) in the LS4 is used for this purpose.
-  Ventilation signal from EV is not supported. This means that test of "State D" is not possible.
-  Adapters for charging connectors are not allowed to be used.
-  Cord extension sets for charging cable is not allowed to be used.
-  Do not use private power generators as a power source for charging.
-  Incorrect installation and testing of the LS4 stations could potentially damage either the vehicles battery and/or the LS4 itself.
-  Do not operate the LS4 stations in temperatures outside its operating range – see technical specifications.

GENERAL INFORMATION

-  Each LS4 station is pre-programmed from factory and tested according to the specification from customer. There is no need for any programming or setup by installer during installation.
-  Each LS4 station is individually marked with a unique "M-number" so that the installer can identify each LS4 station. The M-number label is located at upper right hand side corner behind the front door. When contacting GARO support, please have the M-number available.
-  LS4 stations that are pre-configured for backend-solution have the ChargeBoxID (CBID) labeled under the M-number label.
-  Ethernet cables that are used to connect multiple LS4 should be tested and the result documented to avoid connection problems in future.

INSTALLATION

1. Mount the LS4 and install the supply cable. See picture 1-4.

Phase-rotation is recommended in order to achieve even load on all phases when several LS4 stations are installed to same mains. For example:

1st LS4: L1, L2, L3

2nd LS4: L3, L1, L2

3rd LS4: L2, L3, L1

And so on....

Note: When DLM is pre-configured from factory, follow the marked phase order label at incoming terminals. All pre-configured LS4 contains the information about this inside the cabinet

The gasket at the bottom of the LS4 need to tighten properly around the mains cable in order to avoid dirt, dust, bugs etc to enter the LS4. See picture 4.

Note! The touch protection cover need to fix with attached screws to ensure proper earth bonding to the touch protection cover.

2. In cases with LS4 stations connected in a grid, install TP cable CAT6 with RJ45 connectors between each LS4 station and the provided ethernet router/switch (located ie. in the LS4 master. See example of ethernet wiring diagram picture 5, 6.
In cases with LS4 stations connected in a grid, installation of the LS4 stations need to follow the installation order in the attached Master/slave file. See table 1.
3. In cases with external energy meter (for DLM function), connect the energy meter communication terminals A- and B+ to LS4 Master station terminals 200 A-) and 201 (B+). The energy-meters modbus adress must be set to #2. The modbus RS-485 communication settings is: Baud 9600, 8bit, 1 stop bit, no parity
4. Turn on the electric power.
5. Test the LS4 station on both sides with a EVSE-tester or an EV. In cases where authorization (by RFID tag or similar) is needed to start charging please contact the backend administrator.
6. Fill in the warranty form completely.

Example of Master/Slave form for LS4 stations connected in a grid

Role	Serialnumber / M-number
Master	M00001
Slave 1	M00002
Slave 2	M00003
Slave 3	M00004
Slave 4	M00005
Slave 5	
Slave 6	
Slave 7	
Slave 8	
Slave 9	
Slave 10	

NORMAL USE

Connect the charging cable to the EV.



If authorization is activated, please hold a valid RFID-tag against the RFID reader on the side of the LS4 you want to use or use the operator app to authorize charging.





Charging will start instant if the EV is ready for charging. See your EV charging manual.

When finishing charging, follow the EV's instructions.



After charging: Release the charging cable from your EV and place the charging cable at designated place.







LED light indication	When	Cause of error
 Firm	No car connected	Charging station available and ready for charging
	Car connected	State B: Car connected but not yet ready for charging
	Car connected	State C: Car connected and ready for charging, but charging station requires authentication to start charging (Free Charging = "OFF").
 Blinking (3 blinks)	When car connects	The charging station detects that the cable is connected, but is yet to detect the car.
 Blinking (30 second blink)	Whenever during operation	Charging station have received command from backend to start charging and is waiting for car to connect.
 Firm	Car connected	Charging is ongoing (state C)
	Car connected	Charging is paused (state B)
 Blinking	Whenever during operation	Charging station/point is reserved for a specific user
 Firm	Whenever during operation	DC fault monitor may be defect.
	Whenever during charging	Residual Circuit Current Breaker (RCCB) triggered.
	Whenever during charging	DC fault detected.
	Whenever during charging	Circuit breaker (MCB) triggered - Overload / short circuit
	Whenever during charging	Type 2 connector motor locking was released/unlocked (the cable can be removed)
	When connecting car	The socket outlet can not engage locking mechanism to lock the connector.
 light on RIGHT side	When connecting car	Charging cable is damaged.
	Whenever during operation	The right side charge controller have lost connection to left side charge controller.
 Firm (3 seconds)	When RFID is presented	RFID card is not valid or not approved by backend.
 Blinking	Whenever during operation	Charging station/point is deactivated.
 Blinking	When RFID is presented	Charging station is verifying the RFID in backend cloud service.

LED light indication	When	Cause of error
 NO LIGHT	Charging station and internal meters are powerless.	<p>The upstream circuit breaker have been triggered.</p> <p>4-pole main circuit breaker inside the bottom of charging station is deactivated.</p>
	Charging station is powerless (no LED light), but the internal meters have power.	1-pole main circuit breaker inside the bottom of charging station is deactivated.
		The 12V power supply unit is deactivated (Green LED-light [DC OK] on 12V supply unit is not lit).
		Upper PCB is not receiving power (DC 12V).
	 NO LIGHT on right side	Directly after powering up station. Left side has LED-light lit, but not right side. No access to left controller web interface.

LED light indication	Measure 1	Measure 2
 Firm	No error	Have you tried everything without success? Contact installer or GARO Support (please have M-number available)
	Check car settings that can influence charging, i.e gear in parking mode, doors closed, car locked etc.	
	Present a valid RFID to the RFID card reader (look for RFID symbol), start charging via mobile app or contact charging station operator to start charging remote via backend.	
If the charger is supposed to work without RFID/app authentication, contact the backend operator and ask them to verify that "Free charging" is set to ON.		
 Blinking (3 blinks)	Connect the charging cable to the vehicle, or verify that cable is connected correctly. If no success, try a different charging cable if available.	
	Connect the charging cable, or verify that cable is connected correctly.	
 Firm	No error	Have you tried everything without success? Contact installer or GARO Support (please have M-number available)
	No error	
 Blinking	No error (contact backend operator if this is not the desired mode)	

LED light indication	Measure 1	Measure 2	
 <p>Firm</p>	<p>If the orange "alarm" LED indicator on the charge controller is firm lit, then the charge controller needs to be replaced.</p> <p>Reset the RCCB inside the charging station.</p> <p>Verify that the 8-pole quick connection on the charge controller is properly connected.</p> <p>Verify correct grounding and phases in building electrical system</p> <p>When car is connected: Disconnect charging cable from the charging station, then the LED indication shall return to GREEN. Reconnect charging cable to start charging. The charging will restart automatically after 15 minutes if cable is not disconnected.</p> <p>Reset circuit breaker.</p> <p>Check internal wiring and components for possible reasons for short circuit.</p> <p>Verify allowed maximum current in backend charger configuration (OperatorCurrentLimit).</p> <p>Check motor locking wiring and connection for damages. Verify that locking mechanism rod and arm are not stuck.</p> <p>Verify that the connector is properly inserted into the socket. Light force may be applied.</p> <p>Verify that there are no foreign objects inside the socket outlet, hence blocking the connector.</p> <p>Verify that the motor locking is properly installed and without visual damages.</p> <p>Check charging cable and connectors for damages. Test with another cable if available.</p> <p>Verify that CP and PP connection pins and wires are not loose or having bad connection.</p> <p>Verify grounding of charging station.</p>	<p>Have you tried everything without success? Contact installer or GARO Support (please have M-number available)</p> <p>Firm Red light will always generate an alarm to the backend operator.</p>	
	<p>Check the cable (USB to micro-USB) connecting the two controllers. Replace cable if needed.</p> <p>If replacing cable does not solve the issue, the charge controller needs to be replaced.</p>		<p>Have you tried everything without success? Contact installer or GARO Support (please have M-number available)</p>
	<p>Verify that the RFID token is approved by backend (contact backend operator).</p> <p>Verify that the RFID token is stored in charger internal memory / whitelist (requires certified technician)</p>		
	<p>Contact backend operator and ask for remote activation.</p>		
	<p>No error</p>		

LED light indication	Measure 1	Measure 2
 NO LIGHT	Reset circuit breaker in upstream switchboard.	Have you tried everything without success? Contact installer or GARO Support (please have M-number available)
	Check mainbreaker, reset it if it is deactivated.	
	Check mainbreaker (1-pole 10A), reset it if it is deactivated.	
	Verify that 12V power supply unit is receiving 220V AC power via terminals L & N.	
	Disconnect red/black cables from the power supply unit terminals marked "+/-".	
	If the power supply unit when red/black cables were disconnected, then it has detected an earth fault in one of the DC powered components (controllers, upper PCB, router/switch etc.) inside the charging station.	
	If LED-light [DC OK] remains turned off, consider replacing the 12V power supply unit.	
	Check red/black cable and connection between DC terminal and upper PCB quick connection (located on far left side of upper PCB in the charging station).	
Verify that the controller has 12 V DC power supplied (4-pole quick connection on down-side of controller -> terminal 1 & 2 from the left) and that the LED-light [Ready] is blinking green. If power supply is ok, but no blinking green, then consider replacing charging controller.		
 NO LIGHT on right side	Verify that the cable (micro-USB on left controller and USB-A on right controller) is properly connected and not damaged. Try replacing with a new cable.	Have you tried everything without success? Contact installer or GARO Support (please have M-number available)

LED light indication	Indication / fault code in Web UI	OCPP fault code
 Firm	IDLE (available) - (A) Vehicle not connected	
	IDLE (available) - (B) Vehicle connected not ready	
	IDLE (available) - (C) Vehicle connected ready	
 Blinking (3 blinks)	IDLE (available) - (A) Vehicle not connected	
 Blinking (30 second blink)	AUTHORIZED (available) - (A) Vehicle not connected	
 Firm	CHARGING (occupied) - (C) Vehicle connected ready	
	CHARGING (suspendedEV) - (B) Vehicle connected not ready	
 Blinking		Reserved
 Firm	RCD triggered	groundFailure
	Residual current detected via sensor	groundFailure
	MCB of type 2 socket triggered	overCurrentFailure
	Actuator unlocked while charging	connectorLockFailure
	Plug locking failed	connectorLockFailure
	Possible CP and PR wiring issue.	otherError
 Blinking	UNAVAILABLE (unavailable)	Unavailable

DIMENSIONAL SKETCH

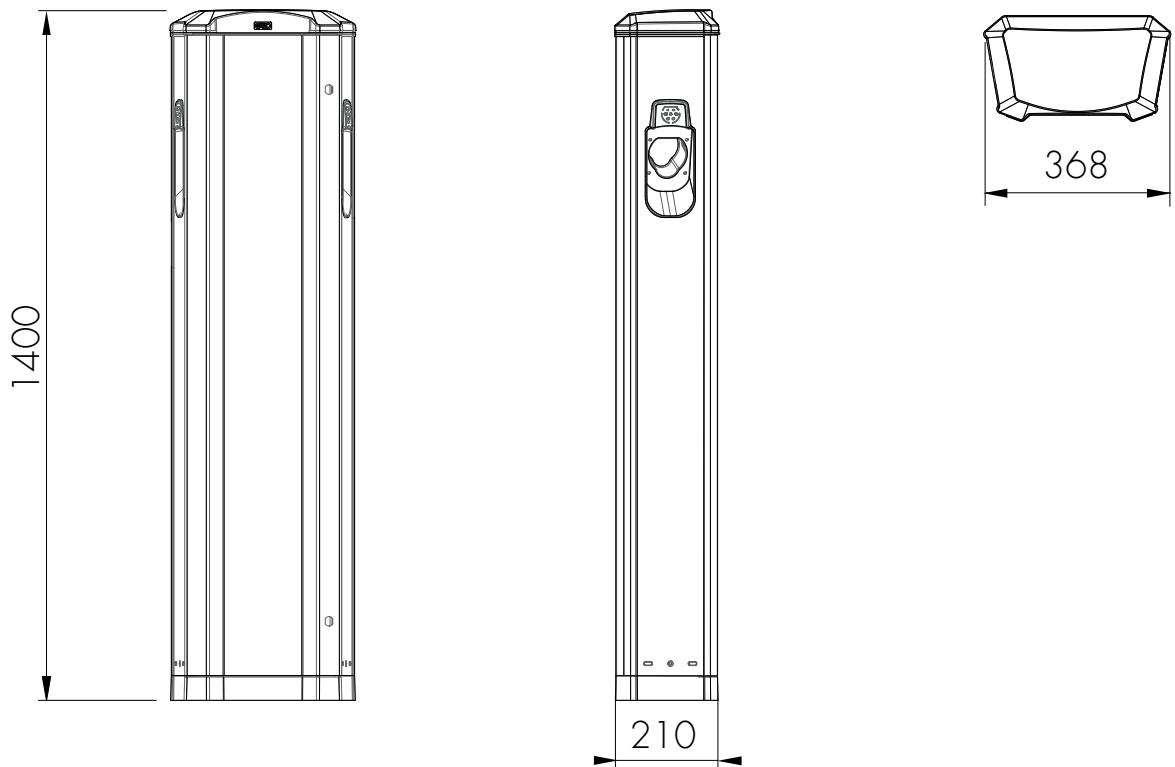

TECHNICAL SPECIFICATIONS

Product type	All LS4 models
Standards / Directives	IEC 61851-1 and IEC 61439-7
	
EMC Classification:	2014/30/EU
Installation method:	Ground / Wall
Installation environment:	Indoor / Outdoor
Location type:	Non-restricted Access
Rated Voltage:	1-phase 230VAC 50Hz / 3-phase 400VAC 50Hz depending on model
Rated Current (configurable)	63A, 32A 1-phase or 3-phase
Installation systems:	TT, TN and IT* systems
Charging type:	Mode 3
Charging method	AC Charging
Protection class:	IP54
Mechanical impact resistance:	IK10
Temperature range:	-25C - +40C
Weight:	22,5 - 24,5kg depending on model
Standard cable length (fixed cable version):	Standard 4m
Rated impulse withstand current	10kA
Rated short-time withstand current	10kA
Rated conditional short-circuit current of an assembly	10kA
Short-circuit protective device type	Type C
Rated impulse withstand voltage	4kV
Rated insulation voltage	230/400V
Rated current of each circuit	32A
Rated diversity factor	RDF=1
Pollution degree:	3
EMC environmental condition	A and B
RFID Frequency Band	13.56MHz
RFID output power	250mW

SERVICE INFORMATION

Care and maintenance GARO charging station LS4:

The warranty will only remain valid if service is performed.

Service is performed once a year and must be documented.

General authorization EL is required to perform service, i.e. only a qualified electrical contractor should perform the service. The service is performed by inspecting the charging station's exterior and interior parts, manipulating components and conducting a functional inspection.

If the charging station is connected to a web portal or otherwise controlled from an external system via a service provider, the service personnel must contact the service provider before a scheduled service. This is to be able to carry

out all steps in the service, but also to avoid automatic error reports being sent from the charging station when service starts that may lead to other service personnel being called out at great expense. Normally the instructions for the charging station indicate whether it is connected to a superior service.

If you have questions about service or a need for service, please contact your GARO retailer.

FORM FOR ANNUAL SERVICE AND MAINTENANCE

Plant ID:

Name:

Date:

Check point for annual service and maintenance:	Status/Value	Comment/remark
Visual check outside cabinet		
LED indication lit		
Check cables, connectors, connector pins		
Check sockets		
Check color, foil and instructions		
Check external antenna (when installed)		
Check fastening/fixing to ground/wall		
Clean LS4 outside surface		
Check locking mechanism		
Check both RCCB by pressing "T" button. Check that LED indication switches to red color for both sides		
Function test by GARO test-equipment or similar		
Check that electrical power is delivered by indications on test equipment		
Check RFID reader (when available). Indication by 2 or 3 flashes from LED:s		
Check Type 2 socket locking function (Type 2 socket versions)		
Turn off the electrical power		
Check gaskets		
Check torque for mains terminals		
Check torque for LS4 fixing screws towards ground/wall		
Check torque for connectors on contactors, relays, energymeters and DC-PSU		
Check connectors on CCU module		
Measure the earthing resistans (Ohm) on EV sockets/cables with a multimeter		
Clean inside when necessary		
Turn on the electrical power		
Check charging function on both sides		

WARRANTY CONDITIONS

EU Countries (except Sweden)

1. The product benefits from manufacturer's warranty. The applicable warranty period must be stated in purchase documents from your supplier.
2. The product must be installed by a certified installer / contractor.
3. Proper installation, storage and operation conditions must be obtained.
4. Warranties apply only to products installed in their original installation location.
5. Installation, use, care, and maintenance must be normal and in accordance with instructions.
6. Warranty requires a dated, fully filled in Warranty form by an certified installer/contractor. If the original installation date cannot be verified, then the warranty period begins ninety (90) days from the date of product manufacture (as indicated by the model and serial number).
7. Warranty does not cover damage occurred by incorrect use of equipment, use of any non-original spare parts, lack of maintenance or faults caused by disassembly of the product or unauthorized persons intervention,
8. Warranty does not cover software or update thereof.
9. Warranty does not cover aesthetic deficiencies caused by negligent manipulation or accidents (breaks or damage to the carcass).
10. Warranty does not cover damage caused by external overvoltage from either grid or car/charging object.
11. Warranty does not cover damage caused by force major like for example but not limited to: floods, winds, fires, lightning, accidents, sabotage, military conflicts, terrorism, volcanos, earthquakes or corrosive environments.

Sverige/Sweden

Garantivillkor enl ALEM 09.

OBS! Fullständigt ifylld garantiblankett krävs.

Garantin gäller ej om produkten varit utsatt för ett isolationstest, sk meggning.

WARRANTY FORM / GARANTIFORMULÄR

LS4 Model: _____

M no: _____

ELECTRICAL INSTALLATION DATA

GROUP FUSE (A): _____

Supply cable dimension: _____

FUNCTION TEST

Testbox / EV (model) _____

DATE: _____

SIGN INSTALLER: _____

COMPANY NAME: _____

OWNER / CUSTOMER NAME: _____

INSTALLATION ADDRESS: _____

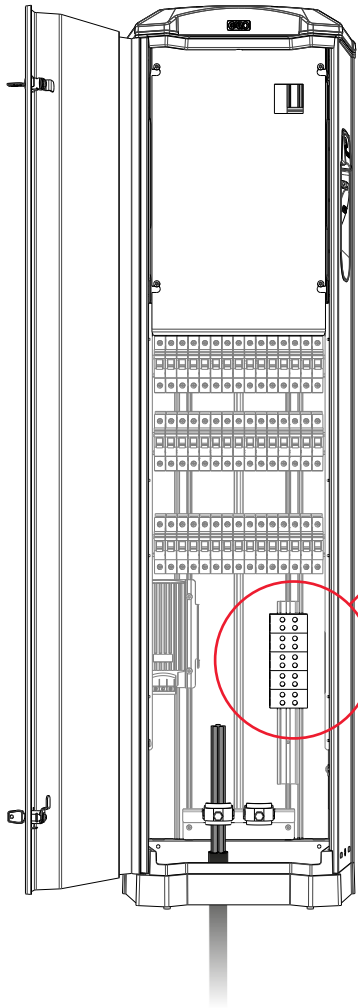

CU/AL
Cu = 2,5Nm Al = 4Nm

(picture 1)

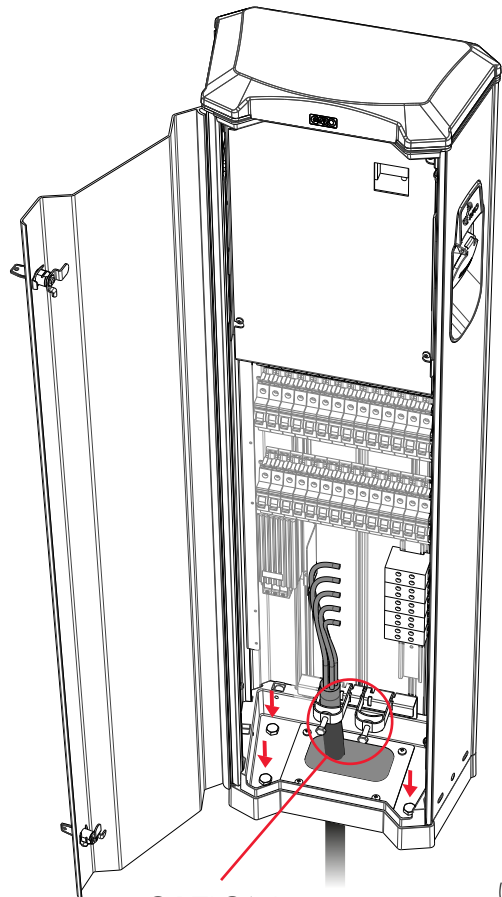

OPTION

(picture 2)

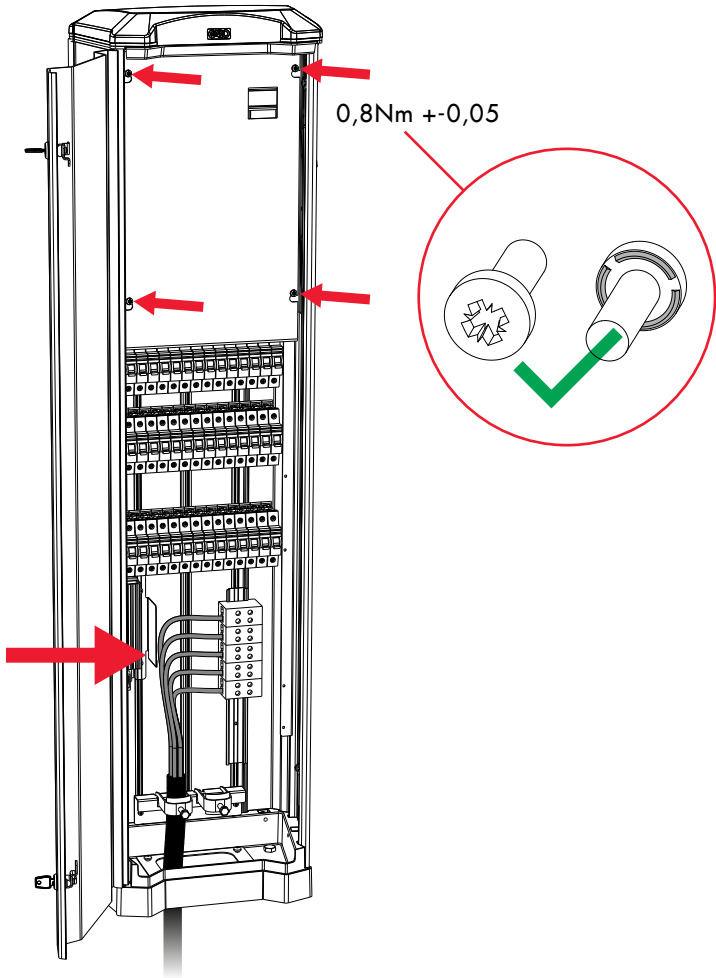

(picture 3)

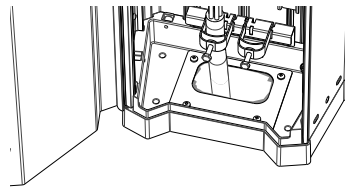
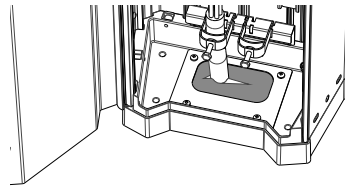
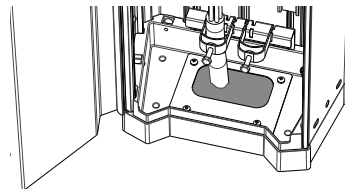

(picture 4)

3pcs LS4 connected with TP CAT6 cable to router/switch

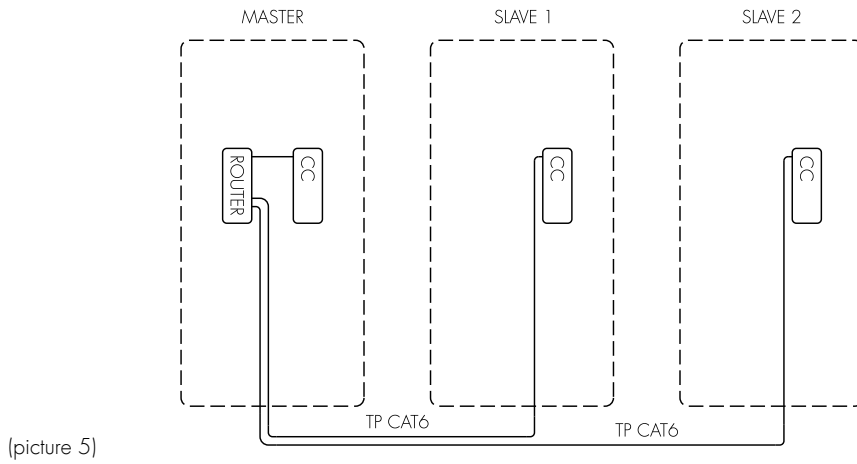

5pcs LS4 connected with TP CAT6 cable to router/switch

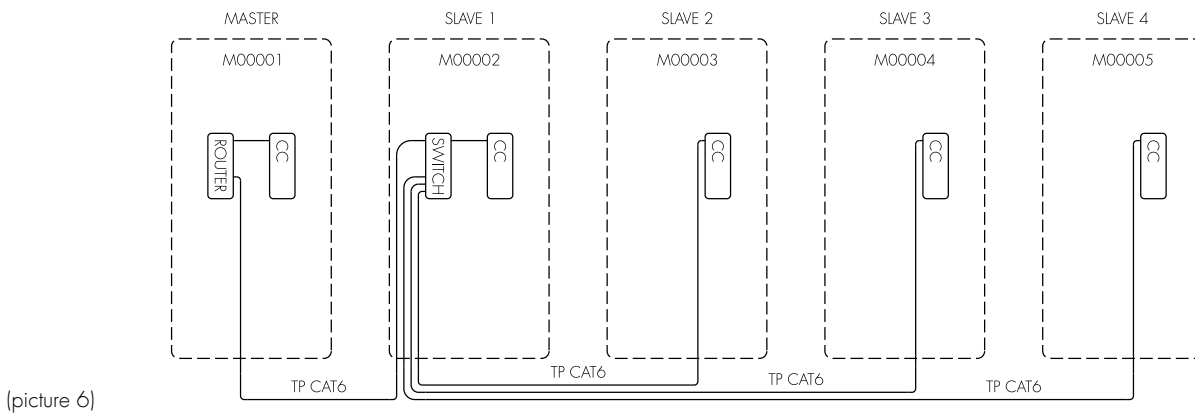

Example of DLM meter installation

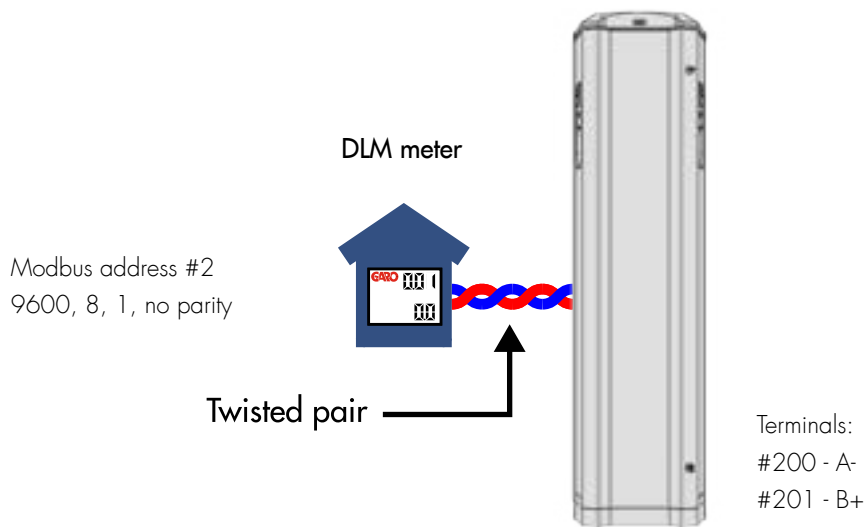

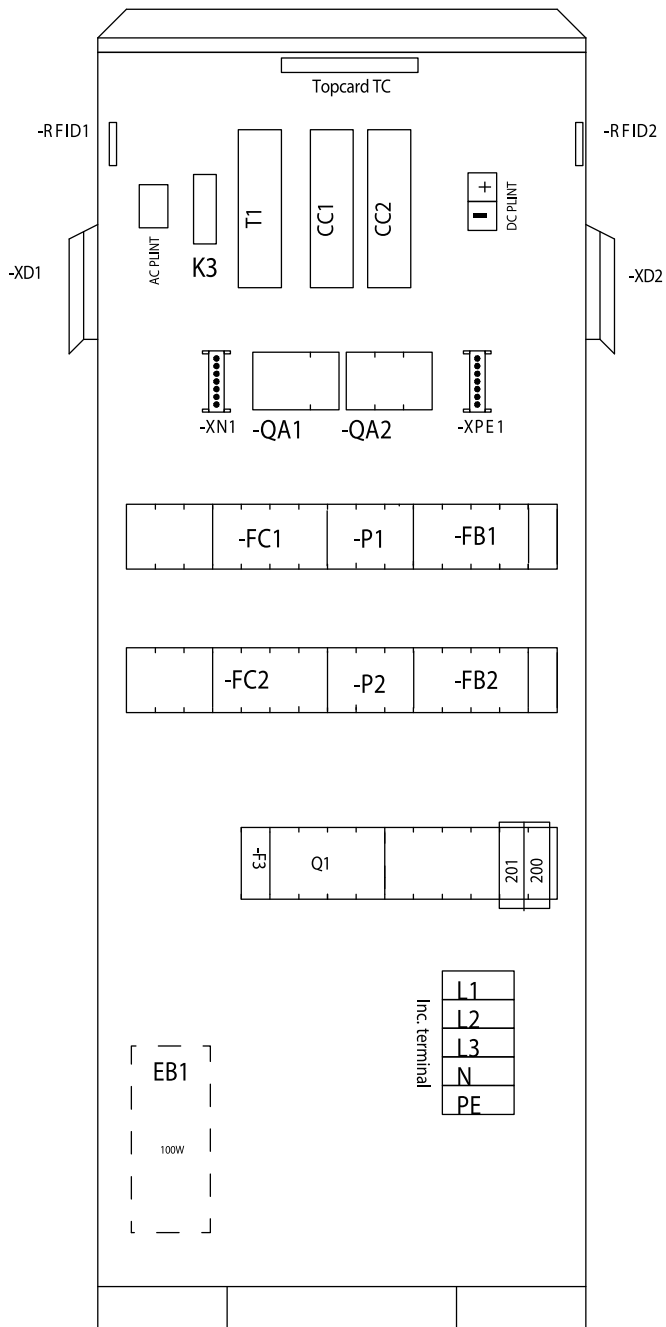

- Q1 = Main breaker
- F3 = Fuse Charge Controller and Powersupply
- P1 = Energymeter Left Outlet
- P2 = Energymeter Right Outlet
- FB1 = RCCB Left Outlet
- FB2 = RCCB Right Outlet
- FC1 = Fuse Left Outlet
- FC2 = Fuse Right Outlet
- QA1 = Contactor Left Outlet
- QA2 = Contactor Right Outlet
- XN1 = N Neutral terminal
- XPE1 = PE Terminal Protection Earth
- T1 = Powersupply DC
- CC1 = Charge Controller (Master)
- CC2 = Charge Controller (Slave)
- RFID1 = Left Receiver
- RFID2 = Right Receiver
- TC = Led light Topcard
- EB1 = Heater Cold Options
- XD1 = Left charging connector
- XD2 = Right charging connector
- K3 = Contactor for Heater Cold Options

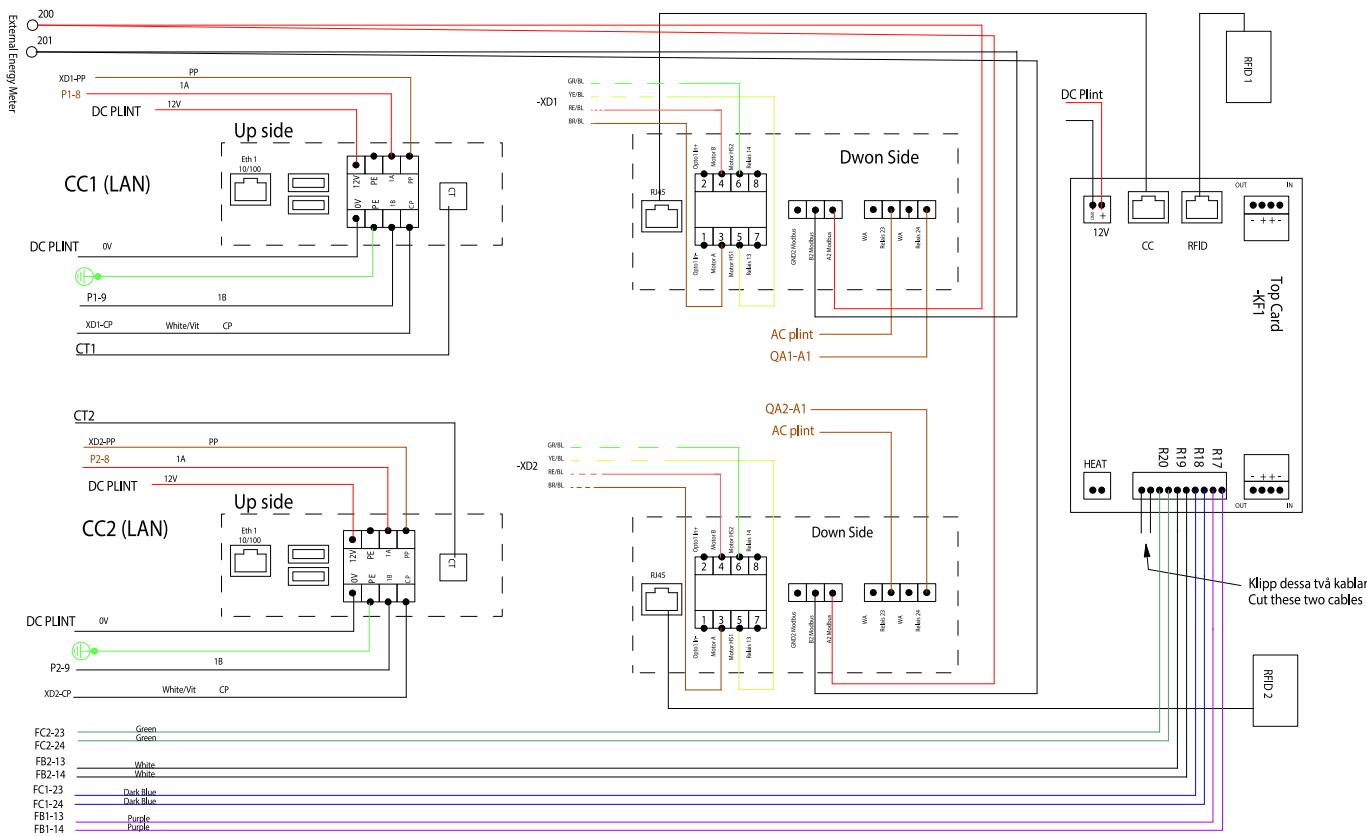
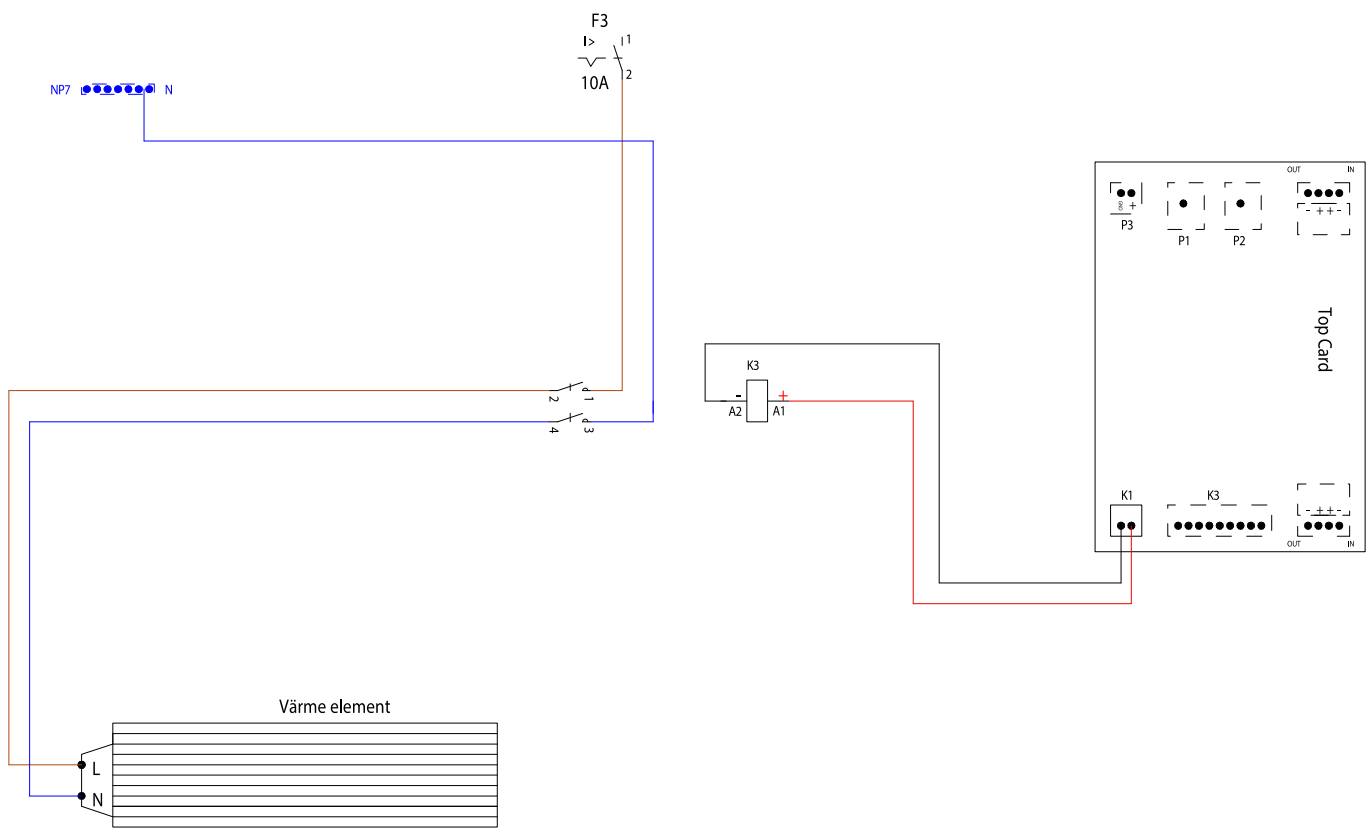



Dokument/document Försäkran om överensstämmelse/ Declaration of conformity		Utgåva datum/edition date 2023-04-05
Avdelning/department Produkt/Product		
Ansvarig/prepared Peter Magnusson	Version 10	Sida/page 1 av/of 1

Manufacturer/Tillverkare: GARO AB
Box 203
S-335 25 GNOSJÖ
Sweden

Telephone: +46 (0)370 33 28 00
Internet: www.garo.se

UK Address: Unit 16, Urban Express Park, Aston Hall Rd, Birmingham B6 7FH

Agent of equipment/Materielslag: Electric Charging Station for EV with Radio Equipment/Laddstation för elbil med tillhörande radio utrustning

Trade Mark/Varumärke: GARO

Type Designation/Typbeteckning: LS4.... and/och LS4M...

We hereby declare under our sole responsibility that our product fulfils the requirements of following directives

Vi intygar härmed under vårt ensamma ansvar att vår produkt uppfyller krav enligt följande direktiv:

- The Low Voltage Directive (LVD) 2014/35/EU / Lågspänningsdirektivet (LVD) 2014/35/EU.
- Electromagnetic compatibility (EMC) 2014/30/EU / Elektromagnetisk kompatibilitet (EMC) 2014/30/EU.
- Radio Equipment Directive 2014/53/EU (RED) / Radiodirektivet (RED) 2014/53/EU.
- RoHS Directive (RoHS) 2011/65/EU / RoHS direktivet (RoHS) 2011/65/EU.
- The Electrical Equipment Safety Regulations 2016/UK / 2016 No 1101
- The Electromagnetic Compatibility Regulations 2016/UK / 2016 No 1091
- The Restriction of the Use of Hazardous Substances in Electrical and Electronic Equipment Regulations 2012/UK / 2012 No 3032

The following harmonised standards (latest edition) or technical specifications which comply with good engineering practice in safety matters in force within the EU/UK have been used in the design:/

Följande harmoniserade standarder (senaste utgåva) eller tekniska specifikationer som uppfyller god säkerhetsteknik praxis inom EU/UK har använts i konstruktionen:

EN IEC 61851-1:2019
EN IEC 61851-21-2:2021
IEC/TS 61439-7:2020

EN 301 489-1 V2.1.1
ETSI EN 301 489-52 V1.1.0 Draft (in part)
EN 301 511 V12.5.1
EN 301 908-1 V13.1.1
EN 301 908-13 V13.1.1
EN 301 908-2 V13.1.1
EN 62311:2020

GARO AB
Company/Företag

Sign/Underskrift

Product Manager /Produktchef
Position/Befattning

Peter Magnusson
Sign in printed letters/Namnförtydligande

Gnosjö 2023-04-05
Place Date/Ort Datum



GARO AB

Box 203, SE-335 25 Gnosjö
Phone: +46 (0) 370 33 28 00
info@garo.se
garo.se

