

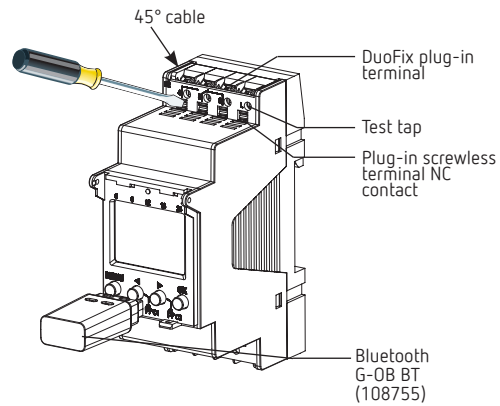

307402 01

EN Time switch

DV1KT3  
108751  
DV2KT3  
108752



## 1. Basic safety information



**WARNING**

**Danger of death through electric shock or fire!**

➤ Installation should only be carried out by a qualified electrician!

- The device is designed for installation on DIN top hat rails (in accordance with EN 60715)
- The device corresponds to type 1 STU in accordance with IEC/EN 60730-2-7
- Power reserve (10 years) is reduced if memory card is inserted (using battery power)

## 2. Proper use

- The time switch is used for lighting, ventilation and flushing applications etc.
- Only for use in closed, dry rooms



Do not use on safety devices, e.g. escape route doors, fire safety equipment etc.

## Disposal

➤ Dispose of device in environmentally sound manner

## 3. Installation and connection

### Mounting the time switch



**WARNING**

**Danger of death through electric shock or fire!**

➤ Installation should only be carried out by a qualified electrician!

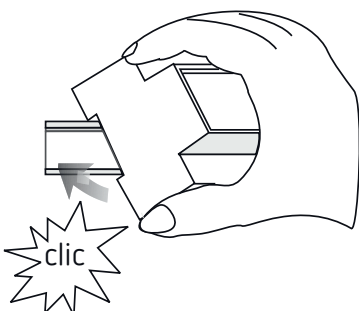

Check the depth of the control cabinet when G-OB BT is connected. The depth must be > 94 mm.

- Mount on DIN top hat rails (as defined in EN 60715)
- Switched voltage-free
- Ensure device cannot be switched on
- Check absence of voltage
- Earth and bypass
- Cover or shield any adjacent live components

## Connecting the cable

### Wiring diagrams 108751 / 108752

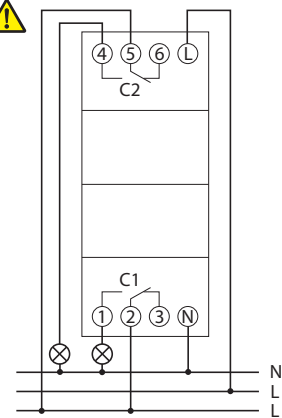
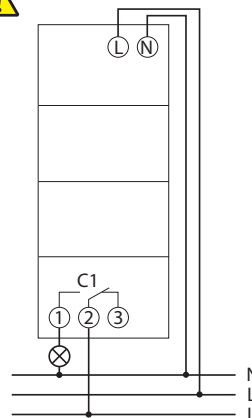

- Strip cable to 8 mm (max. 9)
- Insert cable in the open DuoFix plug-in terminal at 45°
- ⓘ 2 cables per terminal position possible
- To open the DuoFix plug-in terminal, press screwdriver downwards

## Disconnecting the cable

- Use the screwdriver to push the load line connection opener downwards

# 4. Device description

## Display & buttons

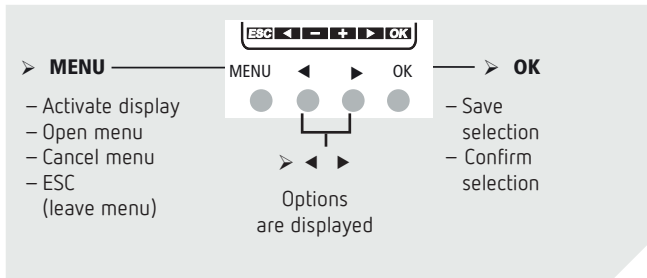
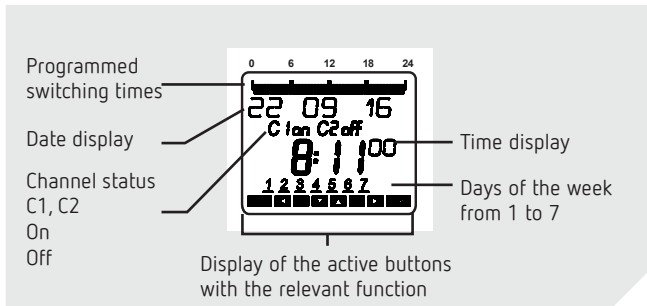

## Operating instructions

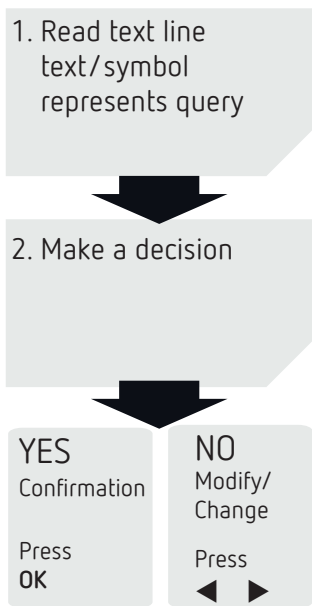

## Overview of navigation menu

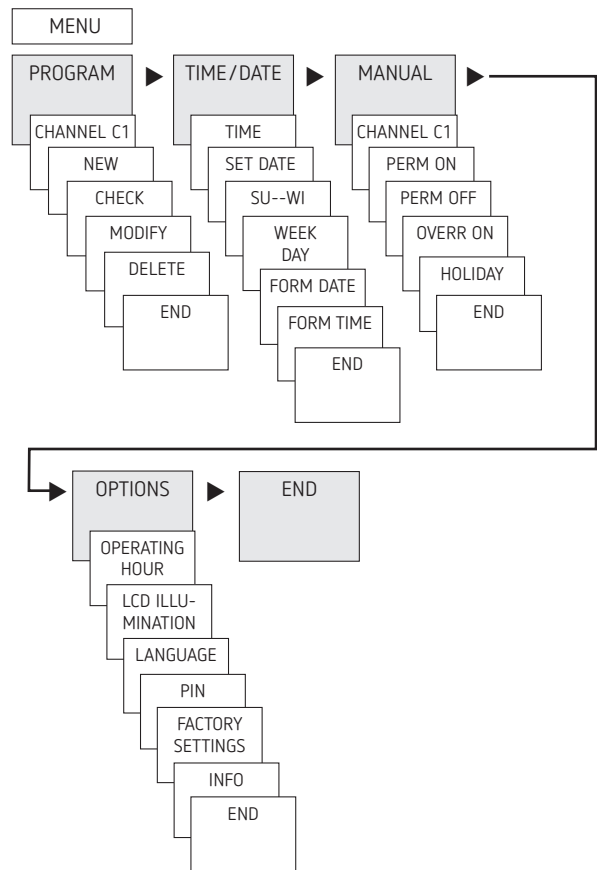

## Initial operation

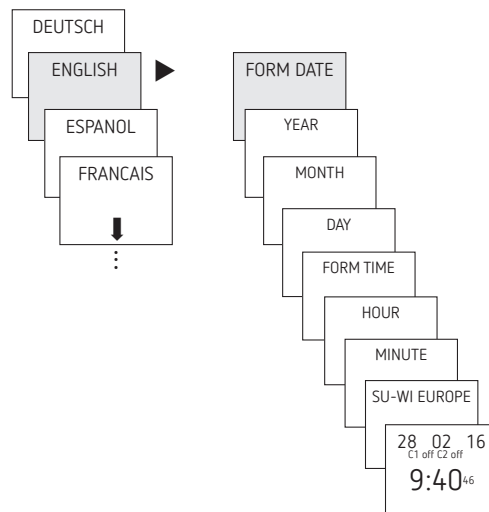

- Set language, date, time as well as summer/winter time (SU-WI)
- Press any button and display follows on screen (see figure)

## 5. Settings and functions

### Set switching time

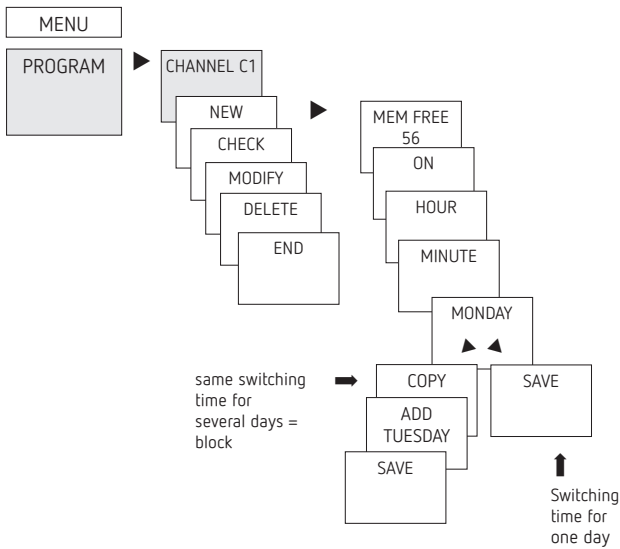

① A switching time always consists of a start time and an end time

① There are 56 memory cells available

Example: Switch on sports hall lighting from Mon–Fri, 7:30 to 12:00 hrs

- Press MENU
- Select PROGRAM and press OK to confirm
- Select CHANNEL C1 or C2, confirm with OK
- Select NEW and press OK to confirm
- Select ON (for turn-on time) or OFF (for turn-off time), confirm with OK
- Set required turn-on time (Mo–Fr, 7:30), confirm with OK
- Select COPY, confirm with OK
- ADD TUESDAY is displayed, confirm by pressing OK and also confirm the days We, Th, Fr by pressing OK.
- Continue with ► until SAVE is displayed.
- Confirm by pressing OK.

Repeat all steps for the turn-off time, however instead of selecting ON with ► select OFF and enter 12:00 for hour and minute.

### Change switching times

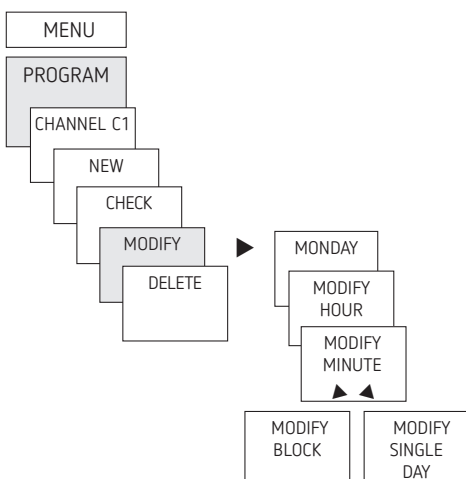

① You can either change or delete a block, i.e. a switching time copied for several days (e.g. Mon–Fri) or a single switching time

### Change individual switching times

- Press MENU
- Select PROGRAM and press OK to confirm
- Select CHANNEL C1 or C2, confirm with OK
- Select MODIFY, confirm by pressing OK
- Select day, confirm with OK
- MODIFY HOUR, use the + or – buttons to change hour and minute and confirm with OK.
- To change several switching times, select MODIFY BLOCK, confirm with OK

### Delete switching program

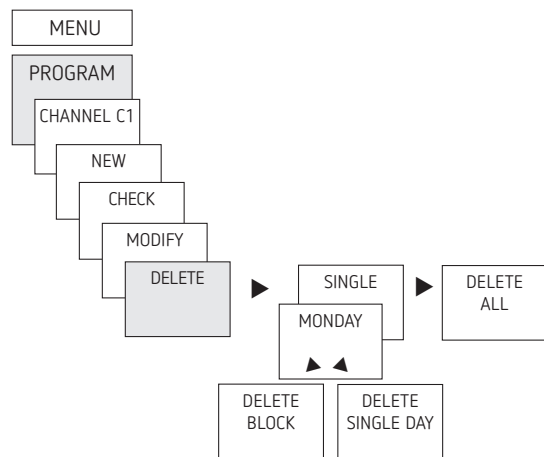

① You can either delete a block, i.e. a switching time copied for several days (e.g. Mon–Fri) or a single switching time

- Press MENU
- Select PROGRAM and confirm with OK
- Select CHANNEL C1 or C2, confirm with OK
- Select DELETE, confirm with OK
- INDIVIDUAL is displayed (with ► DELETE ALL), confirm with OK
- MONDAY is displayed, confirm with OK
- Select DELETE BLOCK, confirm with OK
- With ► DELETE MONDAY etc. individual days can also be cleared.

## Setting holiday function

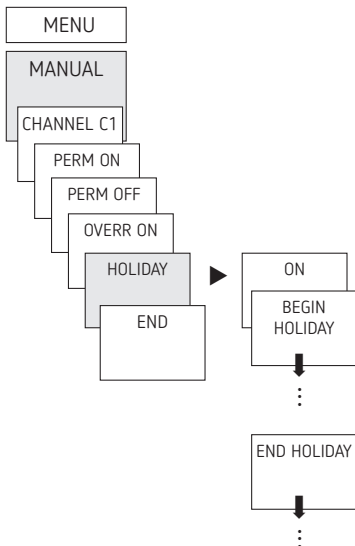

- Press MENU
- Select MANUAL and press OK to confirm
- Select CHANNEL C1 or C2, confirm with OK
- Select HOLIDAY and press OK to confirm
- Select ON and press OK to confirm
- Select START HOLIDAY and press OK to confirm
- Enter YEAR, MONTH, DAY, HOUR and press OK to confirm
- Select END HOLIDAY and press OK to confirm
- Enter YEAR, MONTH, DAY, HOUR and press OK to confirm

## Activating PIN code

The PIN code is set in OPTIONS via the menu.

- ① If you have forgotten your PIN, call the Garo Hotline.
- ① Have the serial number ready.

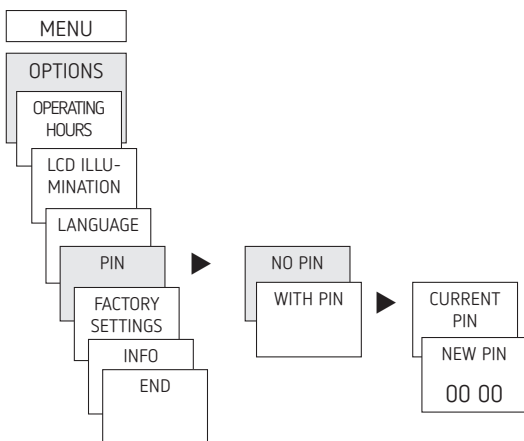

## Setting manual or permanent switching

Manual or permanent switching can be set via the menu in MANUAL or (in the automatic screen) by button combination (see picture).

- Manual control:  
Reversing the channel status to the next automatic or programmed switching.
- Permanent switching:  
As long as a permanent switching (on or off) is activated, the programmed switching times are ineffective

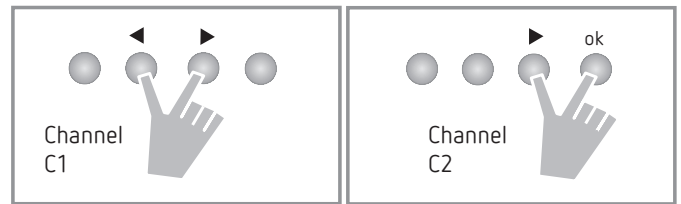

### Activating manual control

- Briefly press both buttons simultaneously

### Activating permanent switching

- Press both buttons simultaneously for 2 seconds

### Cancelling manual/permanent switching

- Press both buttons simultaneously

## Hour counter

The operating hours of the channel (relay) are displayed and deleted in the OPTIONS menu. If the number of operating hours exceeds the value set in the Service menu, SERVICE will appear in the display.

Example: Replace a lamp after after 5,000 h.

- Delete operating hours or set a higher value in Service (e.g. to 10,000 h)

## Using Bluetooth G-OB BT

All functions can also be transferred to the time switch using the Bluetooth G-OB BT memory card (108755).

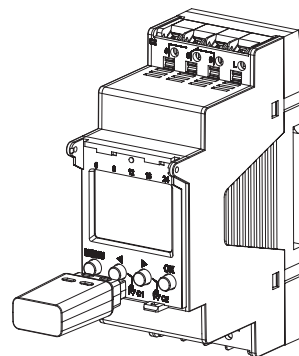

### Copying OBELISK → TIME SWITCH

This copies the switching program and optionally all time switch settings (e.g. external input, time format etc.) from the memory card in the time switch.

### Copying TIME SWITCH → OBELISK

This copies all switch programmes and settings from the time switch to the memory card.

### Starting OBELISK program

Takes on the switching times that are programmed on the memory card.

As soon as the memory card is removed, the switching times of the time switch are re-activated.

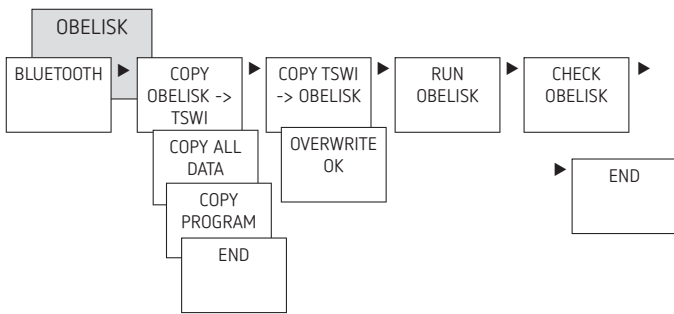

Now, for example, projects can be created and uploaded.

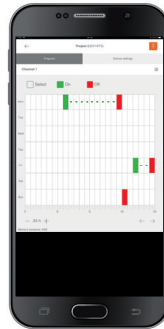

## Connect time switch, Bluetooth G-OB B and smartphone (via app)

The devices in the DVKT3 range can be programmed using an app (for Android, iOS) on a mobile end device. Communication takes place via Bluetooth G-OB BT. Switch programmes are transferred and direct switch commands are sent to the device.

- Download the Time Switch app from the App Store or Google Play Store



ⓘ Bluetooth connection only possible in automatic mode, not in manual mode like OPTIONS etc.

- Open the app and activate using one of the 3 commands, by pressing „Download“ (📶), „Manual command“ (👉) or „Upload“ (📶)

→ Device/device list appears on the display.

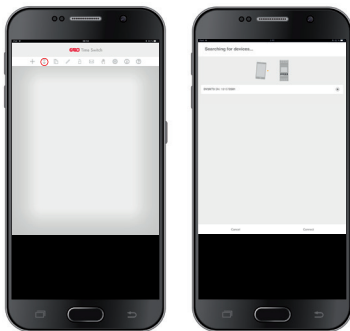

- Press „Connect“



- Press OK on the time switch  
→ The display shows BLUETOOTH ACTIVE
- Press „Close“ in the app within 30 s

## Resetting the time switch

- Press the 4 buttons simultaneously  
→ You can choose between KEEP PROGRAM and DELETE PROGRAM

## 6. Technical data

Operating voltage:	230 V AC +10 % / -15 %
Frequency:	50 – 60 Hz
Standby:	0,4 W
Max switching capacity:	16 A (at 250 V, cos φ = 1)
switching capacity:	10 A (at 250 V, cos φ = 0,6)
Min. switching capacity:	10 mA/230 V AC 100mA/ 24 V AC/DC
Switch output:	switching of any phase is permitted (DV2KT3)
DV1KT3:	suitable for switching SELV (Safe Extra-Low Voltage)
Shortest switching time:	1 min
Switching accuracy:	accurate to the second
Protection rating:	IP 20 in accordance with EN 60529
Protection class:	II in accordance with EN 60730-1 subject to designated installation
Operating temperature:	-30 °C ... +55 °C
Power reserve:	10 years at +20 °C (without Bluetooth G-OB BT)
Time accuracy (typical):	±0,25 s/day (25 °C)
Rated impulse withstand voltage:	4 kV
Pollution degree:	2
Contact:	two way switch
Glow lamp load:	2600 W
Halogen lamp load:	2600 W
Fluorescent lamp load: uncorrected:	2600 VA
Series corrected:	2600 VA
parallel-corrected:	1300 VA (130 µF)
Compact fluorescent tubes (EVG):	1100 W
LED lamps (< 2 W):	50 W

LED lamps (> 2 W):	600 W
Bluetooth G-OB BT: – Protection rating: – Temperature: – Range:	IP 40 –30 °C to +55 °C 15 m on open air test site
Software class:	A

① The time switch display is only fully functional at temperatures from +5 °C - +55 °C.

## 7. Contact

Garö AB  
Södergatan 26  
335 33 GNOSJÖ  
SWEDEN  
[www.garo.se](http://www.garo.se)

Hotline:

 +46 370 33 28 00

 [info@garo.se](mailto:info@garo.se)

Hotline:

 +353 1 866 5360

 [info@garo.ie](mailto:info@garo.ie)

Hotline:

 +358 40 180 79 69

 [myynti@garo.fi](mailto:myynti@garo.fi)

Hotline:

 +47 32 89 64 50

 [garo@garo.no](mailto:garo@garo.no)

Hotline:

 +46 370 33 28 00

 [info@garo.se](mailto:info@garo.se)

Hotline:

 +48 91 881 17 70

 [info@garo.com.pl](mailto:info@garo.com.pl)