

Förskruvning
2xM25 ϕ (11-16)
1xM16 ϕ (5-9)

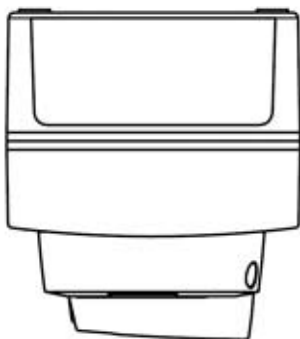
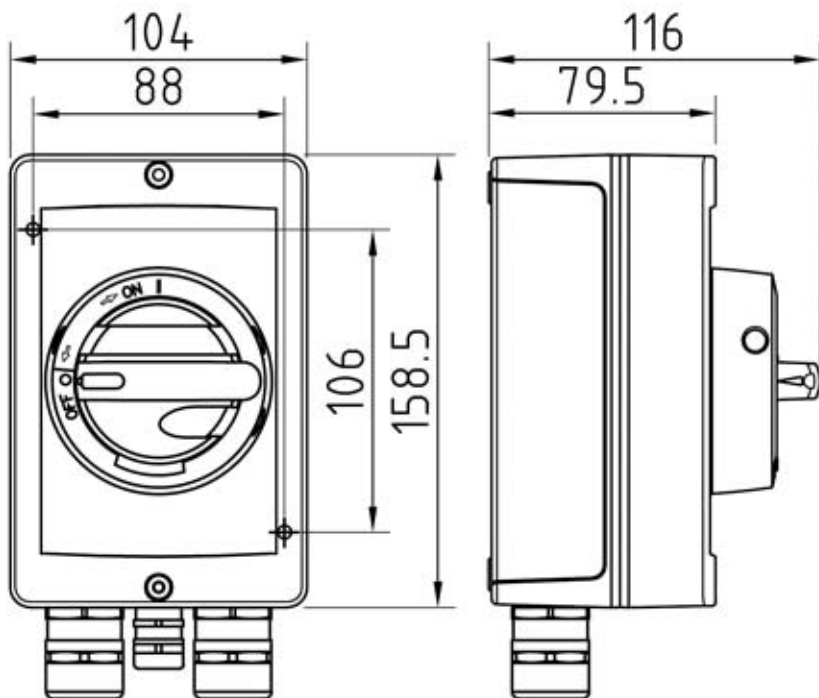

Hjälpkontakt, 1 växlande
Anslutningar, Cu 1.5-16mm²
N, Cu 1.5-16mm²
PE, Cu 1.5-16mm²