

KNOCK-OUT

2x $\phi 25/\phi 32+\phi 16$

upptill och nertill
och $\phi 25$ i botten

Förskruvning

4xM32 $\phi(15-21)$

1xM16 $\phi(5-10)$

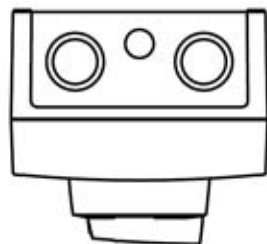
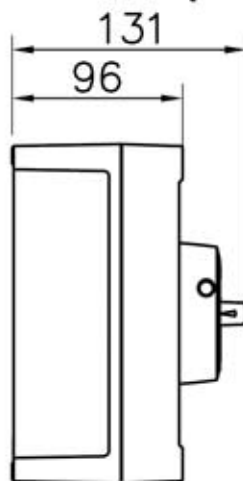
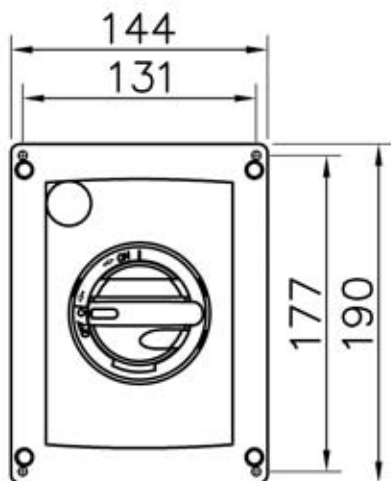
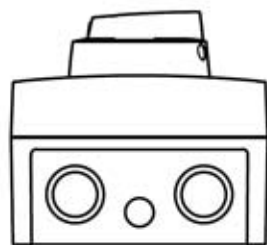

Hjälpkontakt, 1 växlande
Anslutningar, Cu 1.5-16mm²
N, Cu 2.5-35mm²
PE, Cu 2.5-35mm²